

References

Hennie Kortzen, pig farmer in the Netherlands
 "We have been working with the RescueCare™ system for several years already. It's labor-saving and the technical numbers in the farrowing stable increased. We started working with the Helix at the beginning of 2018. That has resulted in a few extra advantages. The milk remains fresh much longer and longer circuits are easier to manage. The Helix contains few wearing parts, it is a durable system."

Alzo farm, Italy
 Family Lavarini runs Alzo farm (1100 Topigs 20 sows) in Valeggio, Italy. They installed the RescueCare™ system in 2017. The farm is managed in a 3 week system with 276 farrowing places. The farm is divided in 2 groups. In one group they installed 144 cups and 6 Rescuedecks and in the other group they don't use Rescue cups. There they see the biggest difference. The average weaning weight of the pigs with the Rescue cup system improved with 420 grams.

Jacob Lee, BRD Corp., South Korea
 "The pig industry is changing more and more to high pro-ductive sows. The amount of live born piglets keeps in-creasing, but the amount of weaned piglets remain the same. Farms that have implemented the RescueCare™ system increased the amount of weaned piglets by 1 to 1.5 and the weaning weight by 500 to 800 grams. Another advantage is that the system is easy to install and to manage at the farms."

Kawiks company, Poland
 Kawiks company in Ligota Poland (700 sows) installed the RescueCare™ system in 2016. The RescueCare™ system contributed to a better organization of the work and improved the technical results. Since they stopped working with foster sows they were able to increase the sow herd with 7%. The pre-weaning mortality decreased with 3% and the mortality after weaning with 1%. The fatteners production increased without expanding the farm.

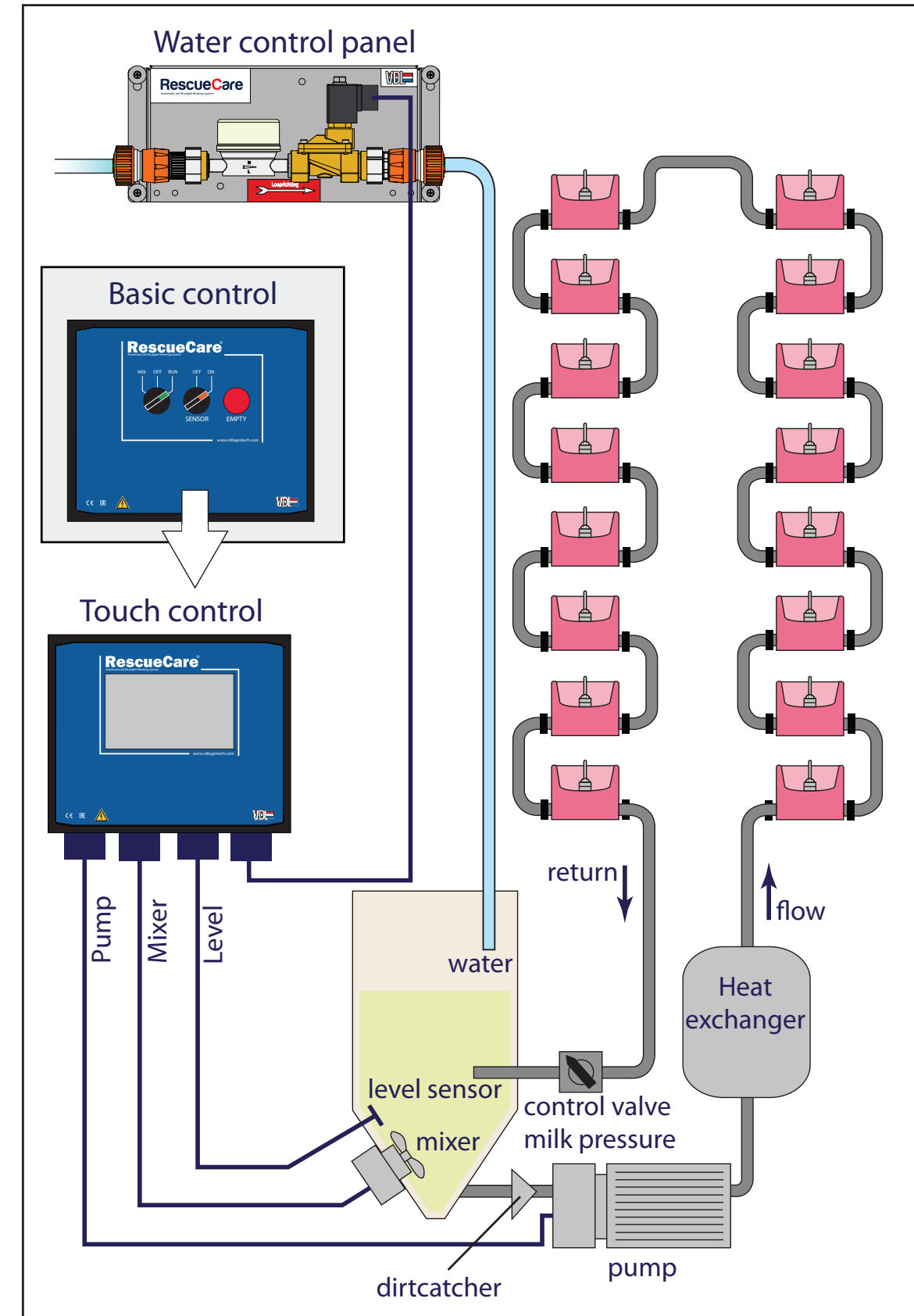

2020RCHX

Follow us on social media

VDL Agrotech
 P.O. Box 8822, 5605 LV Eindhoven, T: +31(0)40 29 25 500
 www.vdiagrotech.com, info@vdiagrotech.nl, F: +31 (0)40 29 25 501

VDL Agrotech



RescueCare™

- Closed system for continuous supply of warm liquid feed
- Maximum feed intake before weaning
- Increased sow performance, more and heavier weaned piglets
- Plug and play, easy to manage system
- Optimal hygiene, due to unique distinctive working mechanism
- Proven, continuous further developed concept

RescueCare™ Cup system

Giving liquid feed in the farrowing pen is becoming increasingly important as modern pig farming faces challenges every day.

The number of live born piglets per litter keeps in-creasing, while the quantity of milk produced by the sow remains at the same level. Therefore the optimal growth of the piglets is difficult to achieve, which has significant consequences for the results up to the first 11 weeks of age.

The RescueCare™ system ensures that piglets have ad lib access to fresh liquid feed from day one.

RescueCare™ Cup system

- Continuous supply of warm and fresh liquid feed to piglets in farrowing pens
- Closed, permanent circular feeding system (24/7)
- Homogeneous feed, due to programmed tank mixing every 30 minutes

Unique features RescueCare™ system

- Plug and play, easy to manage system
- Distinctive approach hygiene
- Ad libitum feeding system
- Patented drinking nipple with backflow and overflow protection
- Nipple easy to activate from day one
- Modular system

Benefits RescueCare™ system

- Increase of 30% in the total delivered kilograms of piglets per sow per year
- Saves on labour (5-10%)
- Return on investment in most cases less than 1 year

Farrowing pen	RescueDecks	Baby room
<ul style="list-style-type: none"> ■ Piglets can stay with the sow in the farrowing crate ■ Piglets are fed with maternal milk ■ Each single piglet in a large litter can benefit 	<ul style="list-style-type: none"> ■ Warm hygienic, dry housing system ■ Placed above the farrowing crate ■ Foster sow no longer necessary 	<ul style="list-style-type: none"> ■ Reduce the amount of foster sows ■ Piglets completely reliable on milk replacer ■ 6-7 piglets per cup

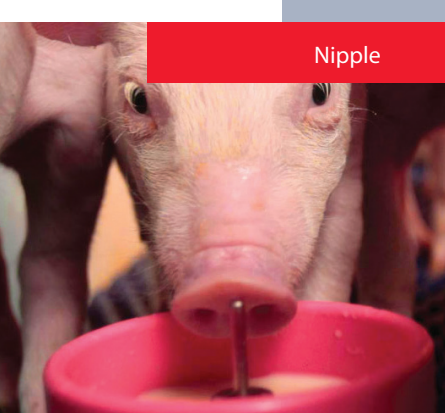

VDL

VDL

Feed kitchen & Mixer tank

Feed kitchen

The feed kitchen is the heart of the installation. The system can be installed in the central corridor, in case space for a feed kitchen is not available. Important is the availability of sufficient hot water.

Mixer tank

The liquid feed (milk or pre-starter) is prepared in a mixer tank. The unique design and use of materials makes it a very fast and easy to clean mixer tank as there are no gaps or seams in the tank surface.

- Safe and easily accessible for cleaning and product preparation
- The unique bottom mixer mixes fast and homogeneous (full tank in 2 minutes)
- Minimum feed residue
- 30 minute interval mixing motor ensures feed homogeneity
- Tanks pre-assembled and plug and play delivered

The mixer tank is available in 100, 200 or 400 litre capacity, depending on the number of cups/decks per tank and how often fresh feed will be prepared. Additional options are: temperature sensor and transparent cover.

Control units

There are two types of controllers available, the Basic and Touch controller. Both types are characterized by:

- User-friendly functional design
- Plug and play installation
- Automatic and manual control of mixer and pump
- All electrical components are compatible (tank/pump/water dosing)
- Water after run standard integrated in all control units

Basic Control Unit:

- Button / Mix-off-run and Sensor on/off

Touch Control Unit:

- 5.8" intuitive colour touchscreen
- Logging and remote controllable and consultable
- Clear and easy operation
- Workflow oriented
- Temperature sensor included
- Optional the Rescue Clean plug and play module can be installed to clean the system fully automatically

Rescue Clean

- Fully automatic cleaning of the circuit
- Can clean up to 2 circuits overnight
- Flushes the circuit, prevents biofilm formulation

Pumping systems

Instead of distributing the feed manually, the RescueCare™ system pumps the feed 24/7 automatically into all compartments. The selected pumps for the RescueCare™ system have accurate flow characteristics and chemical resistance against milk replacers, liquid pre-starters and cleaning agents.

Electric pumping system

- Designed for relatively short circuits, where you can easily operate the entire system with 1 or 2 pumps
- Interesting for farms without air pressure supply
- The flow can easily be adjusted by use of a frequency converter

Pneumatic pumping system

- Designed for farms with air compressor available
- The pumps can be easily installed in a serial set-up to cover longer distances
- Manageable as required with membrane pumps and pressure regulators throughout the circuit

There are several types of pneumatic pumps, depending on the preferences of the farmer and the lay-out of the farrowing house the best suitable pumps will be selected.



Electric pumping system



Helix

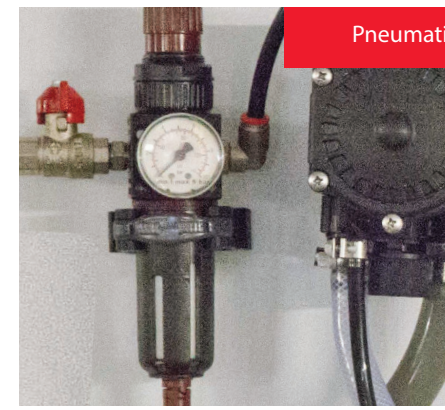

Pneumatic pumping system

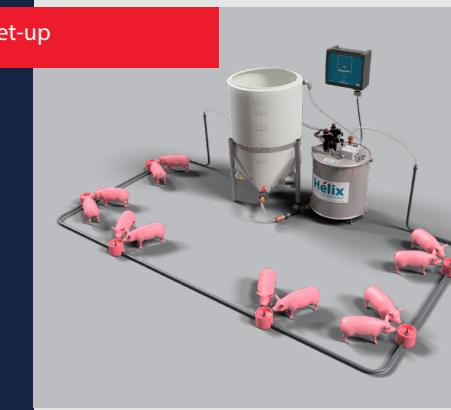

Set-up



Helix

Helix is a high-tech, plug and play assembled system that is connected to the mixer tank and the control system of RescueCare™. The Helix liquid feed system offers several unique advantages compared to other pumping systems.

Helix

- Designed for easier management of the RescueCare™ system
- Plug and play, easy to install high-tech system
- Easy to connect to mixer tank and control system RescueCare™

Milk remains fresh longer

- During the feeding phase, the Helix works as a hydrofor
- Pollution is minimized, guaranteeing a more stable pH content of the milk than any other system
- Automatic prevention milk from sagging
- Retains the temperature in the circuit

Equal pressure across the circuit

- The pressure is uniform from the first to the last cup, thanks to homogeneity pressure in the circuit
- Even distribution, all piglets receive milk at the same time and spillage due to pressure differences is avoided

Longer circuit possible

- One Helix installation is sufficient for a circuit up to 1000 meters length

Sustainable

- Durable in use and in parts
- Contains few wearing parts
- 80- 95% energy saving per system compared to comparable systems with pneumatic or electric pumps

Fast and effective cleaning process

- The milk is pumped out of the pipes under high pressure, after which the cleaning agent is pumped through the pipes with considerable force

Easy management

- Plug and play system
- Easy to install and start using



Plug and play system

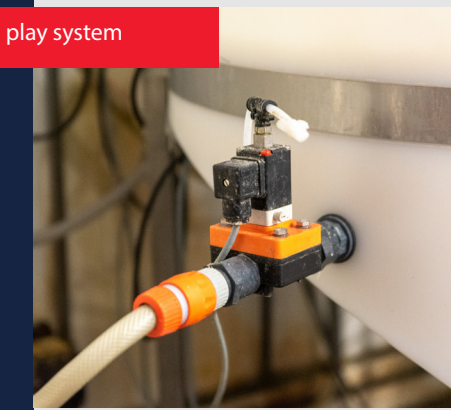

Plug and play system

Heat exchangers & Rescue cup

Heat exchanger

A heat exchanger is required to keep the milk and pre-starter at the right temperature. We offer two types:

- Electric heat exchanger:
 - o Plug and play
 - o System works with 220-230V
 - o Ideal if a central heating system is available
- Standard heat exchanger
 - o Can be connected to the existing central heating system
 - o No additional heating costs



Heat exchanger

Unique drinking cup

The unique design of the RescueCare™ cup ensures that piglets are eager and learn quickly how to activate the nipple.

Patented nipple

- Regulates the feed supply automatically
- Backflow and overflow protection
- When the cup is filled, feed supply will be blocked to prevent flooding
- Feed spillage is avoided and feed in the circuit remains fresh
- Durable and solid design



Drinking cup

Installing method of the cup

Every farrowing pen is unique. Often the experience and the vision of the farmer are integrated in the design. There are several options to install the RescueCare™ cup. This mainly depends on the position of the closed floor, heating plates or canopy:

- Installing with PVC or Pex
- Hoses above or beneath the slats
- Several positioning options of the cup



Farrowing pen

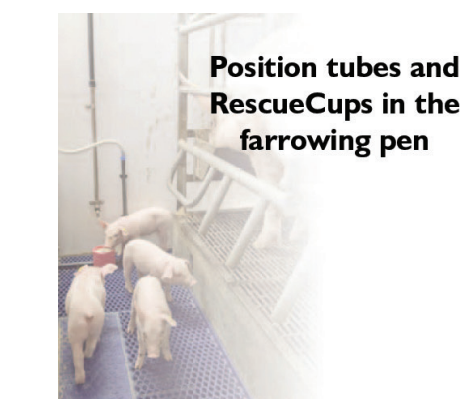

Position tubes and RescueCups in the farrowing pen

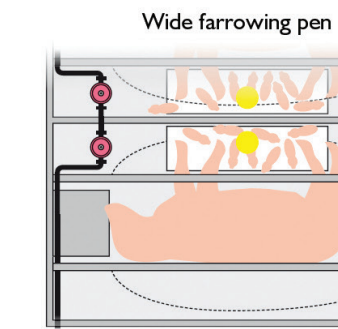

Wide farrowing pen

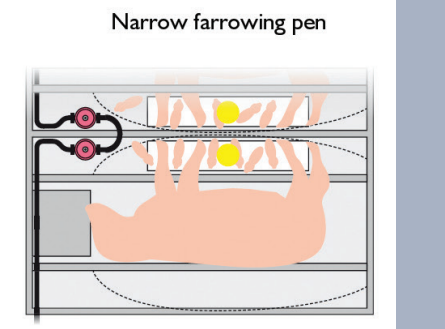

Narrow farrowing pen

